

A10-33-11

REV. 7/06

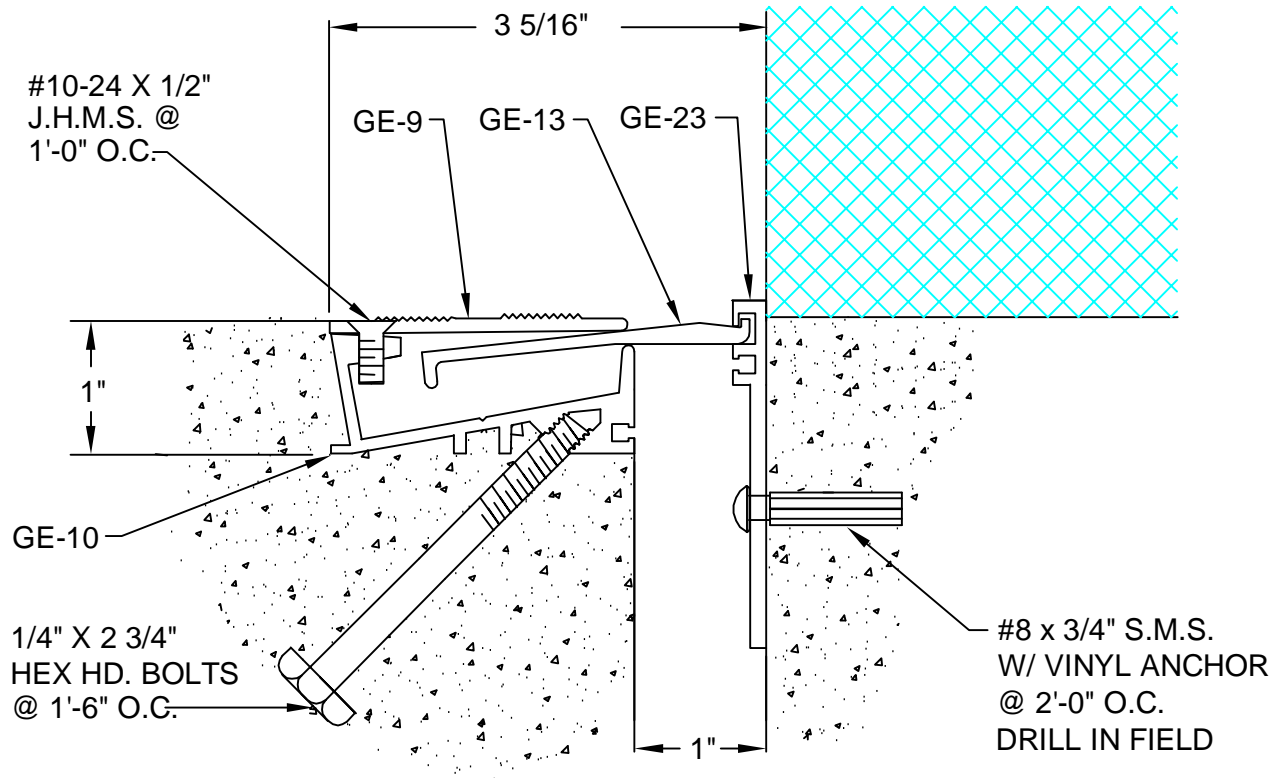

DESCRIPTION: FLOOR-TO-WALL
ALUMINUM: 6063-T5 EXTRUSION
EXPOSED FINISH: MILL
ZINC CHROMATE AREAS IN CONTACT W/ WET CEMENT
ALLOWABLE LOAD: 1748 LB/LF @ MAX. OPENING
MOVEMENT: +/- 50% JOINT WIDTH
STOCK LENGTHS: 20'-0"

CUSTOMER:		
PROJECT:		
LOCATION:		
ARCHITECT:		
CONTRACTOR:		
NOTE:		
JOB NO.:	DATE:	SCALE: (NTS)

LENGTH:	QTY:	COLOR/FINISH: